

- O( %
- \$ , °:
- ' \$' M
- J < CM
- @ - .
- ) )' M&c ( ' %
- J < CM
- @k



<L: \$ . , J' . ' ; MŽIMŽ . , N

O' \$\* ' , M&c

	(1)		(2)			
				120Vac	220Vac	

( ' ' \$ ) + ' M&c  
 ) )' M&c ( ' %  
 J < CM

				@: - ' , O/ \$ ( 2 ) + ' M&c & - ' ? z
				( ' ' % ( ' ' M&c
				( ' ' % ) )' M&c
@k				) )' M&c ) , ° ( ' % @k \$ ( ' % @k = O - ' l j

# INVENTRONICS

EUC-075S070DVY(SVY)

Rev. B

				( ' ' \$ ) . . Mac# , ' \$ ' ? z#- , % \$ ( ' ' %
				Ž+O\$ , N ž

				( ' ' %
				( ' ' %
				( ' ' %
			±	( ' ' %
			+	

( ) M				
( ) M				; im - "

), °:

	o		o	
	o		o	,
	o		o	1, % I? kf ('' % I?
$\check{C} \times N \times ? \check{z}$ $\check{C} \times N \times ? \check{z}$	$- \% ) \times ) \% - \times ( \% +$ $( , / \times - . \% \times * - \%$			$. \% 0 \times ) \% - \times ( \% +$ $( / , \times - . \% \times * - \%$

), °:

' ~ (' M				
' ~ (' M	μ	μ	μ	

), °:

<b>EMS</b>	

EMS	

ž ž <D @

ž ž <D @

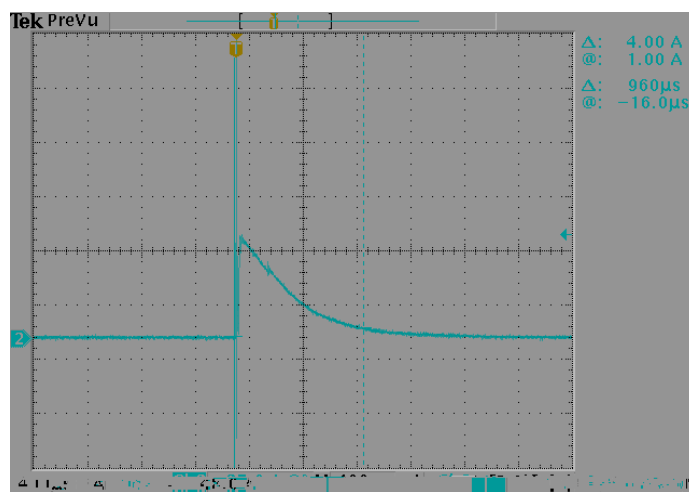
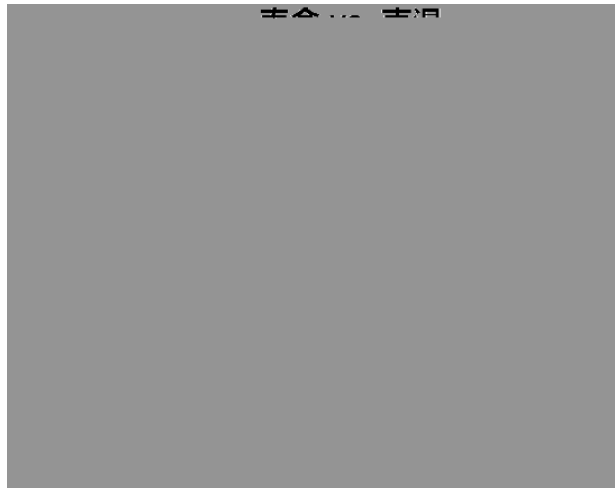

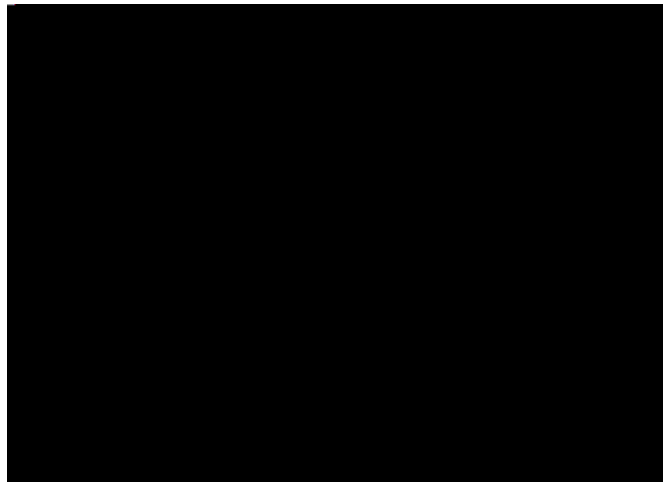
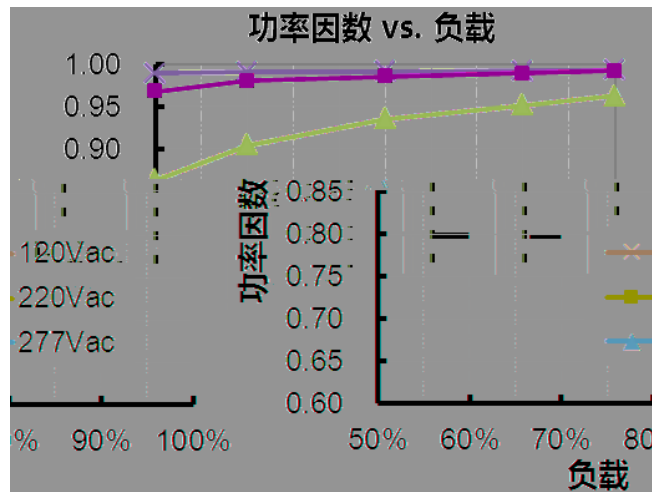
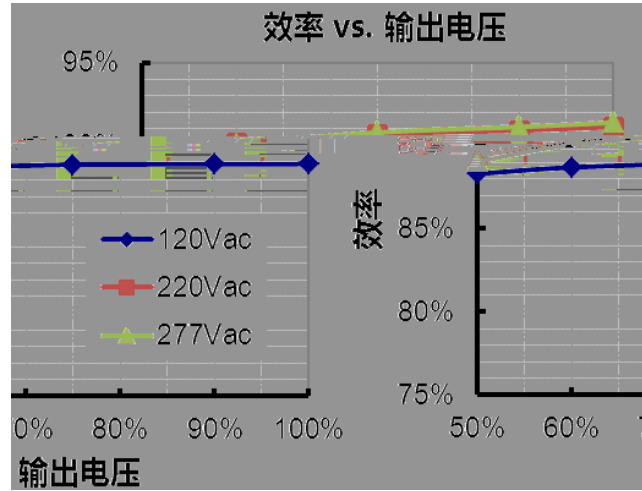

( )' Mac )' Mac

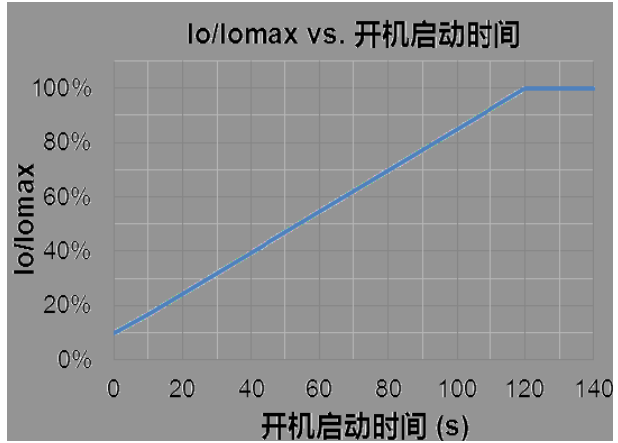
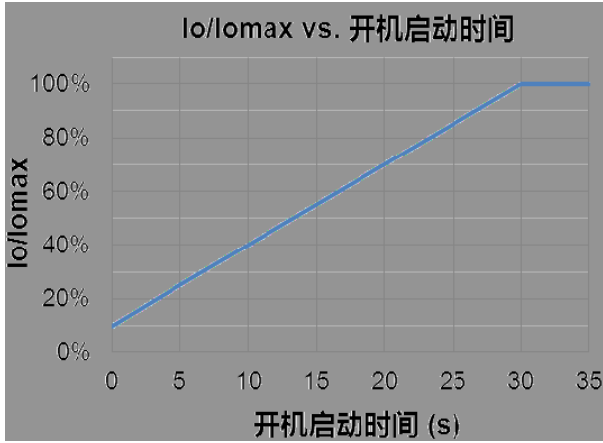

: Ta ° °

: Ta ° °

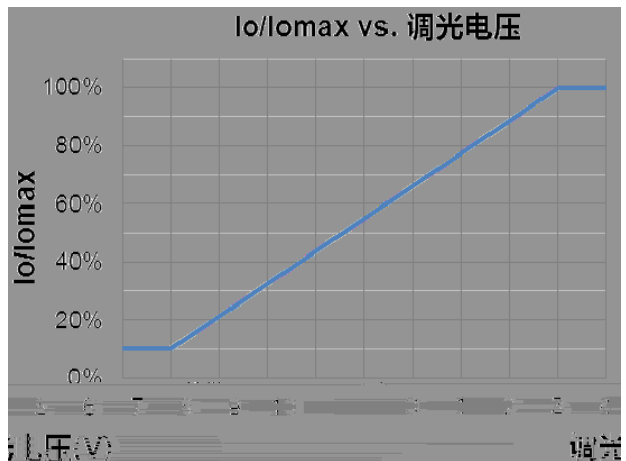
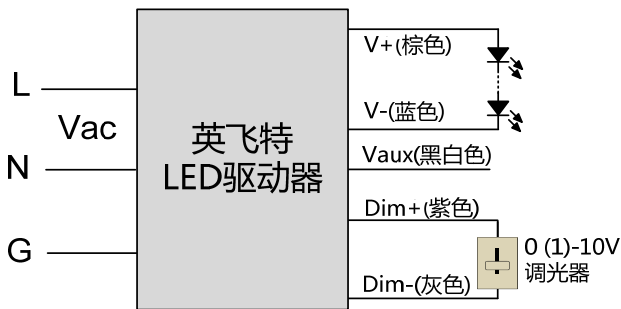

0-10V

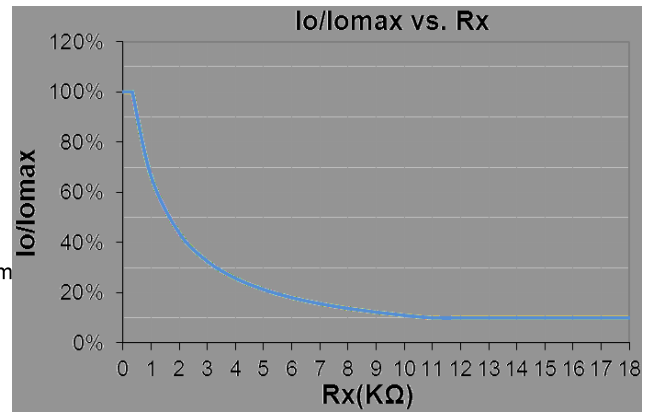
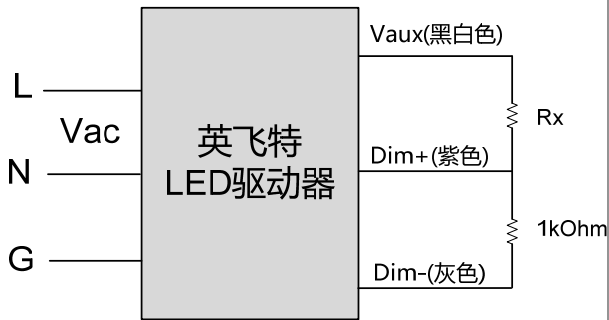
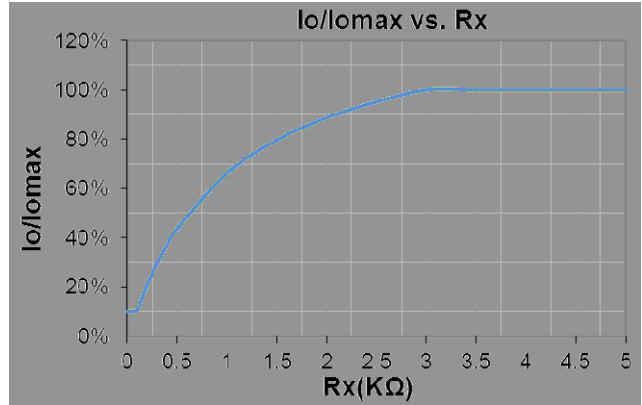
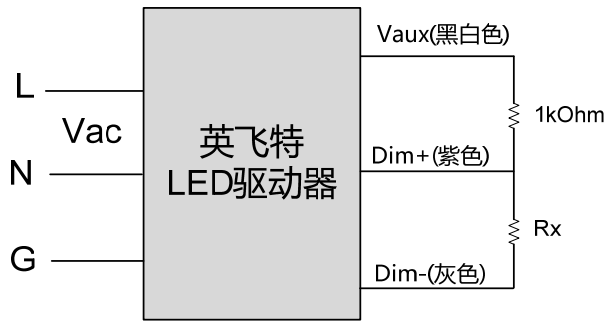

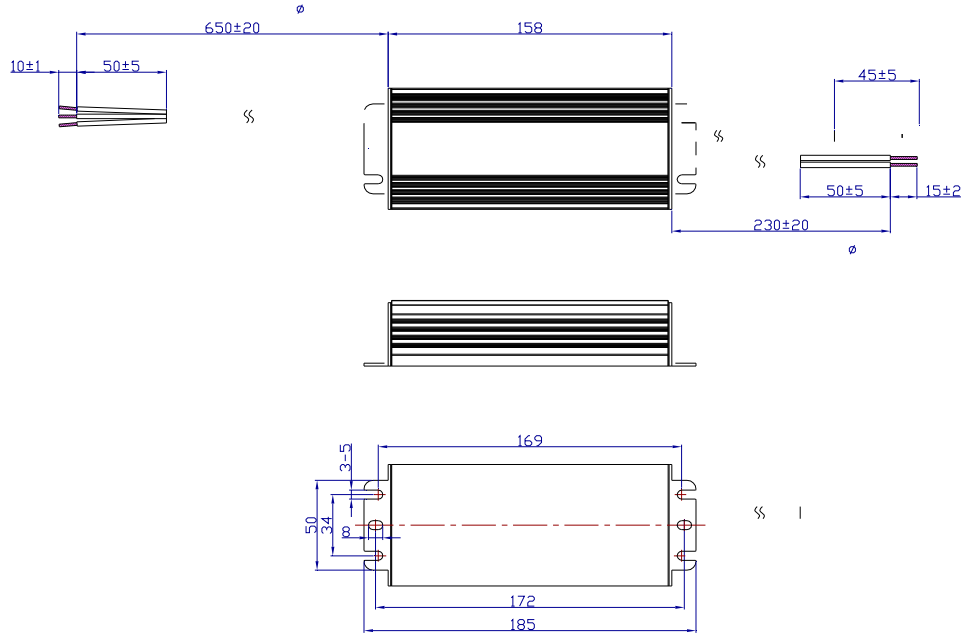

(%        ' \$( ' M  
 )%        ; im\$        M\$    M  
 \*%        ; im"        MAl x

**EUC-075S070DVY**





			&	&
			&	
			&	
			,	
		&	, ' \$ ' ? z	
			&	
			' ~ ( ' M	
			&	
			&	
			&	